

**ISO 16028/350 BAR**

VALVOLA PIANA/ACCIAIO  
 FLAT FACE/STEEL  
 FLACHDICHTEND/STAHL  
 CLAPET PLAT/ACIER

**Caratteristiche tecniche**
**I**

- Norma: ISO 16028 (DN06→DN30)
- Occlusione: faccia piana
- Aggancio: sfere radiali
- Materiale: acciaio
- Finitura: Zn-Fe (Cr III) e Zn-Ni
- Filettature: BSP - NPT - SAE - METRICHE
- Guarnizioni standard: NBR e PU
- Temperatura d'esercizio: -25 °C +100 °C
- Guarnizioni opzionali: FKM, EPDM o altro.
- Pressioni di esercizio: 350-500 bar
- Connessione in pressione residua: non consentita

**Technical data**
**E**

- Standard: ISO 16028 (DN06→DN30)
- Occlusion: flat face
- Locking: radial balls
- Material: steel
- Finishing: Zn-Fe (Cr III) and Zn-Ni
- Threads: BSP - NPT - SAE - METRIC
- Standard seals: NBR and PU
- Working temperature: -25 °C +100 °C
- Optional seals: FKM, EPDM or more.
- Working pressure: 350-500 bar
- Connection under residual pressure: not allowed

**Technische Merkmale**
**D**

- Norm: ISO 16028 (DN06→DN30)
- Verschluss: flachdichtend
- Kupplung: Radial Kugeln
- Werkstoff: Stahl
- Ausführung: Zn-Fe (Cr III) und Zn-Ni
- Gewinde: BSP - NPT - SAE - METRISCHE
- Standard-Dichtungen: NBR und PU
- Betriebstemperatur: -25 °C +100 °C
- Dichtungen nach Wahl: FKM, EPDM, usw.
- Betriebsdruck: 350-500 bar
- Kuppeln unter Restdruck: nicht möglich

**Caracteristiques techniques**
**F**

- Norme: ISO 16028 (DN06→DN30)
- Obturation: clapet plat
- Accrochage: billes radiales
- Matériel: acier
- Traitement: Zn-Fe (Cr III) et Zn-Ni
- Taraudage: BSP - NPT - SAE - METRIQUES
- Joints standard: NBR et PU
- Température de service: -25 °C +100 °C
- Joints facultatifs: FKM, EPDM, ect.
- Pression de service: 350-500 bar
- Connexion sous pression résiduelle: pas possible

Nominal size	Max working pressure	Rated flow	Max flow rate	Min burst pressure			Fluid spillage			
				Male	Female	Coupled				
<b>DNP</b>	<b>BG</b>	<b>ISO</b>	<b>mm</b>	<b>MPa</b>	<b>l/min</b>	<b>l/min</b>	<b>MPa</b>	<b>MPa</b>	<b>MPa</b>	<b>cc</b>
04	0	5	4	50	3	9	250	210	250	0.006
06	1	6.3	6	40	12	24	190	190	190	0.008
13	2	10	8.6	35	23	46	150	170	160	0.010
20	3	12.5	10.7	35	45	90	170	150	170	0.012
22	4A	16	12.8	35	74	150	160	140	150	0.015
25	4	19	14.8	35	100	200	160	140	180	0.020
30	5	25	17.6	35	189	280	140	140	150	0.030

1 MPa = 145.04 psi • 1 l = 0.264 gal

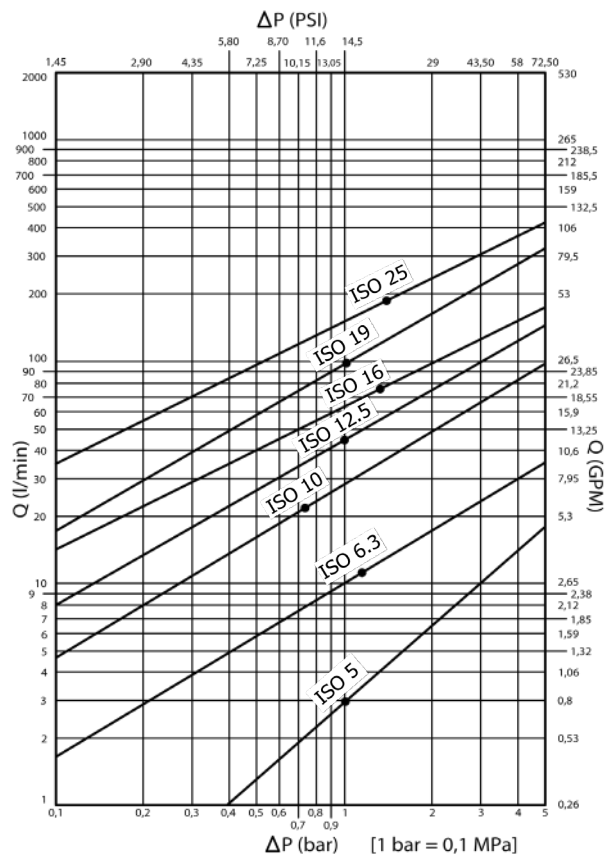

## PLT4 DN04 - BG 0 - ISO 5

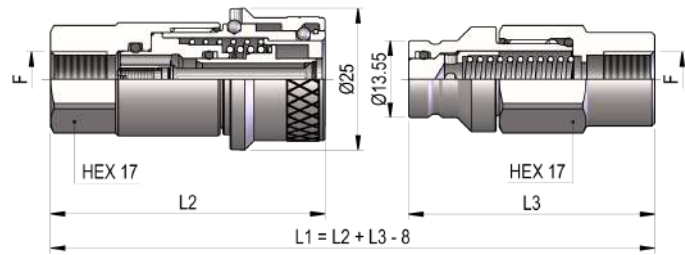

THREADS	L2	L3	F	STANDARD	FEMMINA - FEMALE - MUFFE - FEMELLE			MASCHIO - MALE - STECKER - MALE		
					COD. F	Weight (g)	Packaging (pcs)	COD. M	Weight (g)	Packaging (pcs)
<b>IG 1</b>	48.6	43.5	BSP 1/8"	DIN 3852-2-X	PLT4.0404.112	93	192	PLT4.0404.113	52	300
	48.6	43.5	NPT 1/8"	ANSI B1.20.3	PLT4.0404.012	94	192	PLT4.0404.013	52	300
<b>IG 2</b>	50.6	45.5	7/16"-20 UNF 2B	SAE J 1926-1	PLT4.0412.032	95	192	PLT4.0412.033	54	300

THREADS

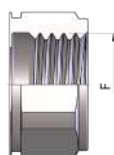

IG 1

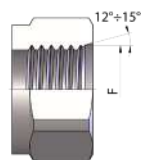

IG 2

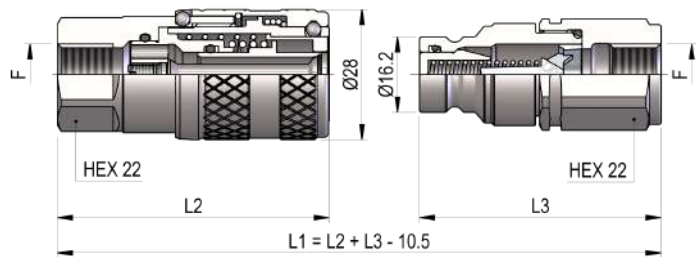
**PLT4 DN06 - BG 1 - ISO 6.3**

THREADS	L2	L3	L4	ØT	F	STANDARD	FEMMINA - FEMALE - MUFFE - FEMELLE			MASCHIO - MALE - STECKER - MALE		
							COD. F	Weight (g)	Packaging (pcs.)	COD. M	Weight (g)	Packaging (pcs.)
<b>IG 1</b>	58.5	52			BSP 1/4"	DIN 3852-2-X	PLT4.0606.112	181	100	PLT4.0606.113	95	200
	58.5	52			NPT 1/4"	ANSI B1.20.3	PLT4.0606.012	182	100	PLT4.0606.013	96	200
	58.5	52			RC 1/4"	EN 10226	PLT4.0606.042	182	100	PLT4.0606.043	98	200
	58.5	52			BSP 3/8"	DIN 3852-2-X	PLT4.0610.112	170	100	PLT4.0610.113	86	200
	58.5	52			NPT 3/8"	ANSI B1.20.3	PLT4.0610.012	173	100	PLT4.0610.013	88	200
	58.5	52			M16x1.5	ISO 6149-1	PLT4.0616.102	173	100	PLT4.0616.103	89	200
	58.5	52			M18x1.5	ISO 6149-1	PLT4.0618.102	166	100	PLT4.0618.103	82	200
<b>IG 2</b>	58.5	52			9/16"-18 UNF 2B	SAE J 1926-1	PLT4.0615.032	178	100	PLT4.0615.033	92	200
<b>AG 7</b>	63.5	53.8	14		NPT 1/4"	ANSI B1.20.3	PLT4.0606.022	169	100	PLT4.0606.023	82	200
	63.5	53.8	14		R 1/4"-19	EN 10226	PLT4.0606.052	168	100	PLT4.0606.053	82	200
	63	53.8	14		NPT 3/8"	ANSI B1.20.3	PLT4.0610.022	173	100	PLT4.0610.023	90	200
<b>AG 5</b>	64	54.3	12		BSP 3/8"	DIN 3852-2-B	PLT4.0610.212	202	100	PLT4.0610.213	88	200
	63.5	53.8	12		BSP 1/4"	DIN 3852-2-A	PLT4.0606.712	172	100	PLT4.0606.713	83	200
	64	54.3	12		BSP 3/8"	DIN 3852-2-A	PLT4.0610.712	202	100	PLT4.0610.713	88	200
<b>AG 2</b>	63.6	53.9	14.1		9/16"-18 UNF 2A	SAE J 514	PLT4.0615.302	194	100	PLT4.0615.303	80	200
<b>AGS 2</b>	82.8	73.1	33.3		9/16"-18 UNF 2A	SAE J 514	PLT4.0615.502	181	70	PLT4.0615.503	93	150
<b>AG 3</b>	59.5	49.8	10	06L	M12x1.5	ISO 8434-1-L	PLT4.0612.302	165	100	PLT4.0612.303	77	200
	59.5	49.8	10	08L	M14x1.5	ISO 8434-1-L	PLT4.0614.302	166	100	PLT4.0614.303	78	200
	60.5	50.8	11	10L	M16x1.5	ISO 8434-1-L	PLT4.0616.302	168	100	PLT4.0616.303	79	200
	60.5	50.8	11	12L	M18x1.5	ISO 8434-1-L	PLT4.0618.302	168	100	PLT4.0618.303	80	200
	61.5	51.8	12	08S	M16x1.5	ISO 8434-1-S	PLT4.0616.402	171	100	PLT4.0616.403	83	200
	61.5	51.8	12	10S	M18x1.5	ISO 8434-1-S	PLT4.0618.402	173	100	PLT4.0618.403	85	200
	61.5	51.8	12	12S	M20x1.5	ISO 8434-1-S	PLT4.0620.402	176	100	PLT4.0620.403	87	200
<b>AGS 3</b>	75.5	65.8	26	06L	M12x1.5	ISO 8434-1-L	PLT4.0612.502	182	70	PLT4.0612.503	94	150
	75.5	65.8	26	08L	M14x1.5	ISO 8434-1-L	PLT4.0614.502	186	70	PLT4.0614.503	98	150
	75.5	65.8	26	10L	M16x1.5	ISO 8434-1-L	PLT4.0616.502	193	70	PLT4.0616.503	104	150
	75.5	65.8	26	12L	M18x1.5	ISO 8434-1-L	PLT4.0618.502	196	70	PLT4.0618.503	109	150
	76.5	66.8	27	08S	M16x1.5	ISO 8434-1-S	PLT4.0616.602	199	70	PLT4.0616.603	112	150
	76.5	66.8	27	10S	M18x1.5	ISO 8434-1-S	PLT4.0618.602	207	70	PLT4.0618.603	119	150
	76.5	66.8	27	12S	M20x1.5	ISO 8434-1-S	PLT4.0620.602	217	70	PLT4.0620.603	128	150

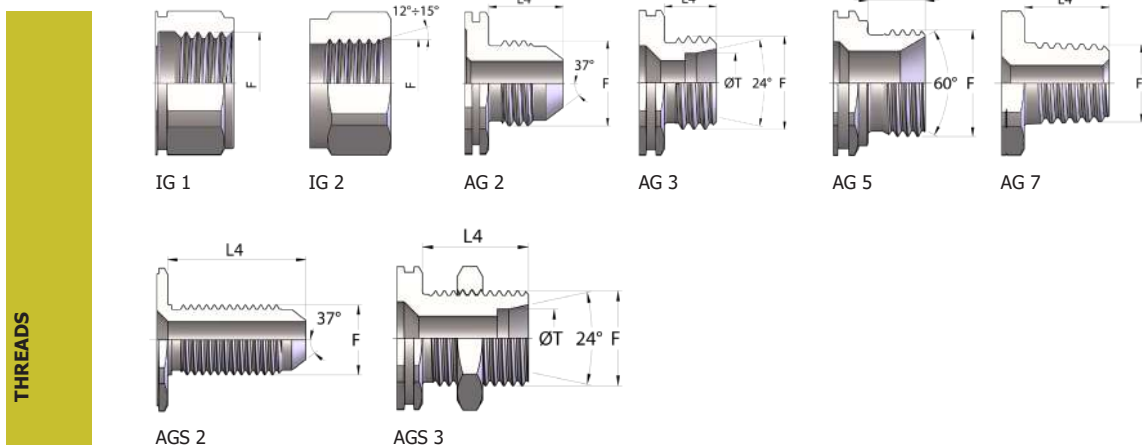

**THREADS**

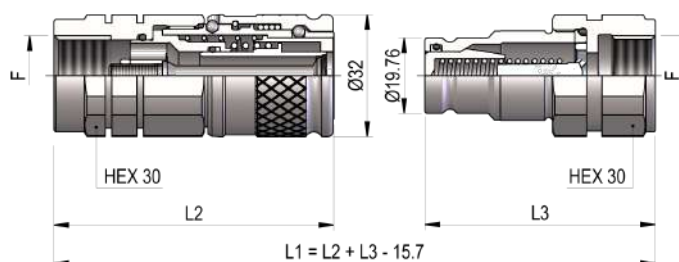
PLT4 DN13 - BG 2 - ISO 10

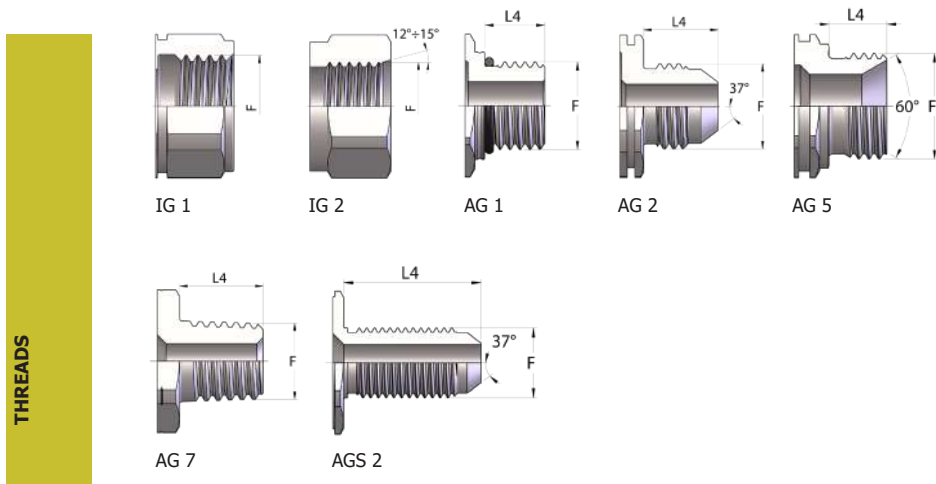

THREADS	L2	L3	L4	ØT	F	STANDARD	FEMMINA - FEMALE - MUFFE - FEMELLE			MASCHIO - MALE - STECKER - MALE		
							COD. F	Weight (g)	Packaging (pcs.)	COD. M	Weight (g)	Packaging (pcs.)
IG 1	73.5	60.5			BSP 1/4"	DIN 3852-2-X	PLT4.1306.112	319	60	PLT4.1306.113	168	60
	73.5	60.5			BSP 3/8"	DIN 3852-2-X	PLT4.1310.112	309	60	PLT4.1310.113	158	60
	73.5	63.5			NPT 3/8"	ANSI B1.20.3	PLT4.1310.012	311	60	PLT4.1310.013	184	60
	73.5	61.5			RC 3/8"	EN 10226	PLT4.1310.042	311	60	PLT4.1310.043	179	60
	73.5	60.5			BSP 1/2"	DIN 3852-2-X	PLT4.1313.112	294	60	PLT4.1313.113	154	60
	73.5	63.5			NPT 1/2"	ANSI B1.20.3	PLT4.1313.012	297	60	PLT4.1313.013	168	60
	74.5	65			RC 1/2"	EN 10226	PLT4.1313.042	301	60	PLT4.1313.043	175	60
	73.5	60.5			M14x1.5	DIN 3852-1-X	PLT4.1314.102	317	60	PLT4.1314.103	167	60
	73.5	60.5			M16x1.5	DIN 3852-1-X	PLT4.1316.102	312	60	PLT4.1316.103	160	60
	73.5	60.5			M18x1.5	DIN 3852-1-X	PLT4.1318.102	305	60	PLT4.1318.103	155	60
	73.5	60.5			M20x1.5	DIN 3852-1-X	PLT4.1320.102	301	60	PLT4.1320.103	157	60
IG 2	72	60.5			9/16-18 UNF 2B	SAE J 1926-1	PLT4.1315.032	309	60	PLT4.1315.033	165	60
	73.5	60.5			3/4"-16 UNF 2B	SAE J 1926-1	PLT4.1319.032	301	60	PLT4.1319.033	158	60
	74.5	64.5			7/8"-14 UNF 2B	SAE J 1926-1	PLT4.1323.032	287	60	PLT4.1323.033	159	60
	74.5	62.5			M16x1.5	SAE J 2244/1	PLT4.1316.112	311	60	PLT4.1316.113	175	60
	74.5	63.5			M22x1.5	SAE J 2244/1	PLT4.1322.102	293	60	PLT4.1322.103	162	60
AG 7	76.5	62.5	14		NPT 3/8"	ANSI B1.20.3	PLT4.1310.022	289	60	PLT4.1310.023	143	60
AG 1	74.5	60.5	13		M14x1.5	ISO 6149-2	PLT4.1314.222	286	60	PLT4.1314.223	134	60
	77.5	63.5	16		M20x1.5	ISO 6149-2	PLT4.1320.222	297	60	PLT4.1320.223	145	60
AG 5	77	62	12		BSP 3/8"	DIN 3852-2-B	PLT4.1310.212	293	60	PLT4.1310.213	136	60
	79	64.5	13		BSP 1/2"	DIN 3852-2-B	PLT4.1313.212	303	60	PLT4.1313.213	144	60
	74	58.5	11		M16x1.5	DIN 3863-U	PLT4.1316.702	283	60	PLT4.1316.703	128	60
	78	63.5	16		M20x1.5	DIN 3863-U	PLT4.1320.702	293	60	PLT4.1320.703	141	60
	76	61.5	14		M22x1.5	DIN 3863-U	PLT4.1322.702	290	60	PLT4.1322.703	138	60
AG 2	77.1	61.6	14.1		9/16"-18 UNF 2A	SAE J 514	PLT4.1315.302	283	60	PLT4.1315.303	126	60
	79.7	64.2	16.7		3/4"-16 UNF 2A	SAE J 514	PLT4.1319.302	291	60	PLT4.1319.303	139	60
AGS 2	100.6	85.1	37.6		3/4"-16 UNF 2A	SAE J 514	PLT4.1319.502	315	60	PLT4.1319.503	162	60
	104.1	88.6	41.1		7/8"-14 UNF 2A	SAE J 514	PLT4.1323.502	330	60	PLT4.1323.503	178	60

segue/follows/folgt/suite →



**PLT4 DN13 - BG 2 - ISO 10**

THREADS	L2	L3	L4	ØT	F	STANDARD	FEMMINA - FEMALE - MUFFE - FEMELLE			MASCHIO - MALE - STECKER - MALE		
							COD. F	Weight (g)	Packaging (pcs.)	COD. M	Weight (g)	Packaging (pcs.)
<b>AG 3</b>	72.5	57.5	10	08L	M14x1.5	ISO 8434-1-L	PLT4.1314.302	278	60	PLT4.1314.303	126	60
	73.5	58.5	11	10L	M16x1.5	ISO 8434-1-L	PLT4.1316.302	279	60	PLT4.1316.303	127	60
	73.5	58.5	11	12L	M18x1.5	ISO 8434-1-L	PLT4.1318.302	280	60	PLT4.1318.303	125	60
	74.5	59.5	12	15L	M22x1.5	ISO 8434-1-L	PLT4.1322.302	286	60	PLT4.1322.303	130	60
	74.5	59.5	12	18L	M26x1.5	ISO 8434-1-L	PLT4.1326.302	301	60	PLT4.1326.303	138	60
	74.5	59.5	12	10S	M18x1.5	ISO 8434-1-S	PLT4.1318.402	285	60	PLT4.1318.403	133	60
	74.5	59.5	12	12S	M20x1.5	ISO 8434-1-S	PLT4.1320.402	288	60	PLT4.1320.403	135	60
	76.5	61.5	14	14S	M22x1.5	ISO 8434-1-S	PLT4.1322.402	293	60	PLT4.1322.403	140	60
	76.5	61.5	14	16S	M24x1.5	ISO 8434-1-S	PLT4.1324.402	296	60	PLT4.1324.403	141	60
	<b>AGS 3</b>	88.5	73.5	26	08L	M14x1.5	ISO 8434-1-L	PLT4.1314.502	297	60	PLT4.1314.503	146
88.5		73.5	26	10L	M16x1.5	ISO 8434-1-L	PLT4.1316.502	304	60	PLT4.1316.503	152	60
88.5		73.5	26	12L	M18x1.5	ISO 8434-1-L	PLT4.1318.502	309	60	PLT4.1318.503	153	60
98.5		83.5	36	12L	M18x1.5	ISO 8434-1-L	PLT4.1318.512	320	60	PLT4.1318.513	164	60
89.5		74.5	27	15L	M22x1.5	ISO 8434-1-L	PLT4.1322.502	334	60	PLT4.1322.503	179	60
89.5		74.5	27	18L	M26x1.5	ISO 8434-1-L	PLT4.1326.502	370	60	PLT4.1326.503	212	60
89.5		74.5	27	10S	M18x1.5	ISO 8434-1-S	PLT4.1318.602	319	60	PLT4.1318.603	167	60
89.5		74.5	27	12S	M20x1.5	ISO 8434-1-S	PLT4.1320.602	328	60	PLT4.1320.603	175	60
91.5		76.5	29	14S	M22x1.5	ISO 8434-1-S	PLT4.1322.602	345	60	PLT4.1322.603	194	60
91.5		76.5	29	16S	M24x1.5	ISO 8434-1-S	PLT4.1324.602	352	60	PLT4.1324.603	199	60

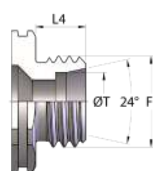
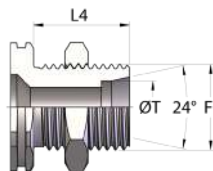
**THREADS**

**AG 3**

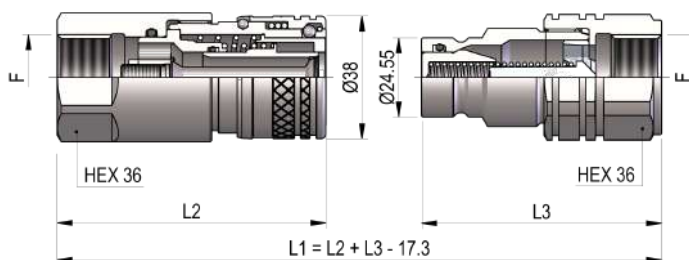
**AGS 3**

## PLT4 DN20 - BG 3 - ISO 12.5

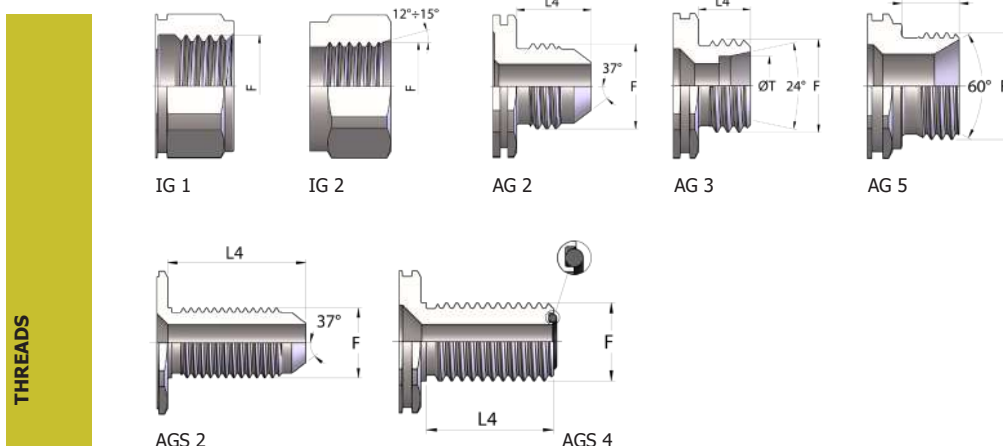

THREADS	L2	L3	L4	ØT	F	STANDARD	FEMMINA - FEMALE - MUFFE - FEMELLE			MASCHIO - MALE - STECKER - MALE		
							COD. F	Weight (g)	Packaging (pcs.)	COD. M	Weight (g)	Packaging (pcs.)
<b>IG 1</b>	83.5	72.5			BSP 1/2"	DIN 3852-2-X	PLT4.2013.112	529	35	PLT4.2013.113	301	42
	83.5	74			NPT 1/2"	ANSI B1.20.3	PLT4.2013.012	532	35	PLT4.2013.013	314	42
	83.5	74			RC 1/2"	EN 10226	PLT4.2013.042	534	35	PLT4.2013.043	315	42
	83.5	74.5			BSP 3/4"	DIN 3852-2-X	PLT4.2019.112	498	35	PLT4.2019.113	282	42
	83.5	74			NPT 3/4"	ANSI B1.20.3	PLT4.2019.012	507	35	PLT4.2019.013	287	42
	83.5	74			RC 3/4"	EN 10226	PLT4.2019.042	511	35	PLT4.2019.043	290	42
	82.5	70.5			M18x1.5	ISO 6149-1	PLT4.2018.102	534	35	PLT4.2018.103	300	42
	82.5	70			M22x1.5	ISO 6149-1	PLT4.2022.102	517	35	PLT4.2022.103	283	42
	83.5	74			M26x1.5	ISO 6149-1	PLT4.2026.102	496	35	PLT4.2026.103	280	42
	83.5	74			M30x1.5	ISO 6149-1	PLT4.2030.102	470	35	PLT4.2030.103	254	42
<b>IG 2</b>	79.5	70			3/4"-16 UNF 2B	SAE J 1926-1	PLT4.2019.032	507	35	PLT4.2019.033	293	42
	81.5	74			7/8"-14 UNF 2B	SAE J 1926-1	PLT4.2023.032	512	35	PLT4.2023.033	306	42
	83.5	74			1"1/16-12 UN 2B	SAE J 1926-1	PLT4.2027.032	492	35	PLT4.2027.033	276	42
<b>AG 2</b>	87.2	75.7	16.7		3/4"-16 UNF 2A	SAE J 514	PLT4.2019.302	451	35	PLT4.2019.303	248	42
	89.8	78.3	19.3		7/8"-14 UNF 2A	SAE J 514	PLT4.2023.302	461	35	PLT4.2023.303	257	42
	92.5	81	22		1"1/16-12 UN 2A	SAE J 514	PLT4.2027.302	488	35	PLT4.2027.303	272	42
<b>AGS 2</b>	108.1	96.6	37.6		3/4"-16 UNF 2A	SAE J 514	PLT4.2019.502	494	30	PLT4.2019.503	286	42
	111.6	100.1	41.1		7/8"-14 UNF 2A	SAE J 514	PLT4.2023.502	510	30	PLT4.2023.503	291	42
	115.9	104.4	45.4		1"1/16-12 UN 2A	SAE J 514	PLT4.2027.502	544	30	PLT4.2027.503	324	42
<b>AG 5</b>	86.5	78	16		BSP 3/4"	DIN 3852-2-A	PLT4.2019.712	477	35	PLT4.2019.713	273	42
<b>AGS 4</b>	111	99.5	40.5		1"-14 UNS 2A	SAE J 1453	PLT4.2025.532	539	30	PLT4.2025.533	323	42
	112	100.5	41.5		1"3/16-12 UN 2A	SAE J 1453	PLT4.2030.532	581	30	PLT4.2030.533	367	42
<b>AG 3</b>	81.5	70	11	12L	M18x1.5	ISO 8434-1-L	PLT4.2018.302	453	35	PLT4.2018.303	239	42
	82.5	71	12	15L	M22x1.5	ISO 8434-1-L	PLT4.2022.302	458	35	PLT4.2022.303	244	42
	82.5	71	12	18L	M26x1.5	ISO 8434-1-L	PLT4.2026.302	466	35	PLT4.2026.303	250	42
	84.5	73	14	22L	M30x2	ISO 8434-1-L	PLT4.2030.302	468	35	PLT4.2030.303	254	42
	82.5	71	12	10S	M18x1.5	ISO 8434-1-S	PLT4.2018.402	460	35	PLT4.2018.403	243	42
	82.5	71	12	12S	M20x1.5	ISO 8434-1-S	PLT4.2020.402	462	35	PLT4.2020.403	246	42
	84.5	73	14	14S	M22x1.5	ISO 8434-1-S	PLT4.2022.402	466	35	PLT4.2022.403	250	42
	84.5	73	14	16S	M24x1.5	ISO 8434-1-S	PLT4.2024.402	469	35	PLT4.2024.403	252	42
	86.5	75	16	20S	M30x2	ISO 8434-1-S	PLT4.2030.402	481	35	PLT4.2030.403	267	42

segue/follows/folgt/suite →



THREADS

**PLT4 DN20 - BG 3 - ISO 12.5**

THREADS	L2	L3	L4	ØT	F	STANDARD	FEMMINA - FEMALE - MUFFE - FEMELLE			MASCIO - MALE - STECKER - MALE		
							COD. F	Weight (g)	Packaging (pcs.)	COD. M	Weight (g)	Packaging (pcs.)
<b>AGS 3</b>	96.5	85	26	12L	M18x1.5	ISO 8434-1-L	PLT4.2018.502	484	30	PLT4.2018.503	267	42
	97.5	86	27	15L	M22x1.5	ISO 8434-1-L	PLT4.2022.502	508	30	PLT4.2022.503	292	42
	97.5	86	27	18L	M26x1.5	ISO 8434-1-L	PLT4.2026.502	542	30	PLT4.2026.503	324	42
	104.5	93	34	22L	M30x2	ISO 8434-1-L	PLT4.2030.502	576	30	PLT4.2030.503	361	42
	97.5	86	27	10S	M18x1.5	ISO 8434-1-S	PLT4.2018.602	491	30	PLT4.2018.603	276	42
	97.5	86	27	12S	M20x1.5	ISO 8434-1-S	PLT4.2020.602	508	30	PLT4.2020.603	286	42
	99.5	88	29	14S	M22x1.5	ISO 8434-1-S	PLT4.2022.602	515	30	PLT4.2022.603	302	42
	99.5	88	29	16S	M24x1.5	ISO 8434-1-S	PLT4.2024.602	528	30	PLT4.2024.603	310	42
	104.5	93	34	20S	M30x2	ISO 8434-1-S	PLT4.2030.602	571	30	PLT4.2030.603	356	42

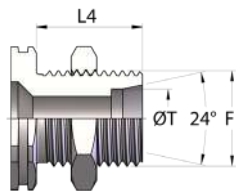
**THREADS**

AGS 3

## PLT4 DN22 - BG 4A - ISO 16

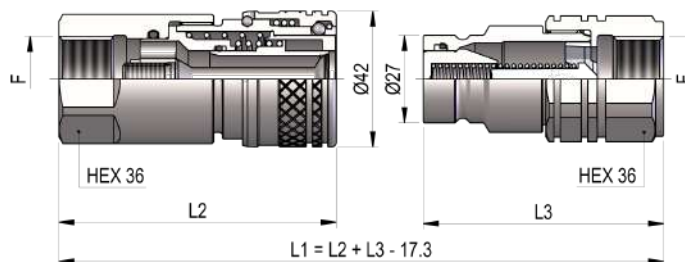

THREADS	L2	L3	L4	ØT	F	STANDARD	FEMMINA - FEMALE - MUFFE - FEMELLE			MASCHIO - MALE - STECKER - MALE		
							COD. F	Weight (g)	Packaging (pcs.)	COD. M	Weight (g)	Packaging (pcs.)
<b>IG 1</b>	86	72.5			BSP 1/2"	DIN 3852-2-X	PLT4.2213.112	576	30	PLT4.2213.113	326	42
	86	74			NPT 1/2"	ANSI B1.20.3	PLT4.2213.012	579	30	PLT4.2213.013	340	42
	86	74			RC 1/2"	EN 10226	PLT4.2213.042	581	30	PLT4.2213.043	340	42
	86	74.5			BSP 3/4"	DIN 3852-2-X	PLT4.2219.112	545	30	PLT4.2219.113	307	42
	86	74			NPT 3/4"	ANSI B1.20.3	PLT4.2219.012	553	30	PLT4.2219.013	312	42
	86	74			RC 3/4"	EN 10226	PLT4.2219.042	558	30	PLT4.2219.043	315	42
	85	70.5			M18x1.5	ISO 6149-1	PLT4.2218.102	580	30	PLT4.2218.103	325	42
	85	70			M22x1.5	ISO 6149-1	PLT4.2222.102	563	30	PLT4.2222.103	308	42
	86	74			M26x1.5	ISO 6149-1	PLT4.2226.102	542	30	PLT4.2226.103	305	42
	86	74			M30x1.5	ISO 6149-1	PLT4.2230.102	516	30	PLT4.2230.103	279	42
<b>IG 2</b>	82	70			3/4"-16 UNF 2B	SAE J 1926-1	PLT4.2219.032	553	30	PLT4.2219.033	318	42
	84	74			7/8"-14 UNF 2B	SAE J 1926-1	PLT4.2223.032	558	30	PLT4.2223.033	331	42
	86	74			1"1/16-12 UN 2B	SAE J 1926-1	PLT4.2227.032	538	30	PLT4.2227.033	301	42
<b>AG 2</b>	89.7	75.7	16.7		3/4"-16 UNF 2A	SAE J 514	PLT4.2219.302	497	30	PLT4.2219.303	273	42
	92.3	78.3	19.3		7/8"-14 UNF 2A	SAE J 514	PLT4.2223.302	507	30	PLT4.2223.303	282	42
	95	81	22		1"1/16-12 UN 2A	SAE J 514	PLT4.2227.302	535	30	PLT4.2227.303	297	42
<b>AGS 2</b>	110.6	96.6	37.6		3/4"-16 UNF 2A	SAE J 514	PLT4.2219.502	540	30	PLT4.2219.503	311	42
	114.1	100.1	41.1		7/8"-14 UNF 2A	SAE J 514	PLT4.2223.502	557	30	PLT4.2223.503	316	42
	118.4	104.4	45.4		1"1/16-12 UN 2A	SAE J 514	PLT4.2227.502	591	30	PLT4.2227.503	349	42
<b>AG 5</b>	90	78	16		BSP 3/4"	DIN 3852-2-A	PLT4.2219.712	524	30	PLT4.2219.713	298	42
<b>AGS 4</b>	113.5	99.5	40.5		1"-14 UNS 2A	SAE J 1453	PLT4.2225.532	586	30	PLT4.2225.533	348	42
	114.5	100.5	41.5		1"3/16-12 UN 2A	SAE J 1453	PLT4.2230.532	628	30	PLT4.2230.533	392	42
<b>AG 3</b>	84	70	11	12L	M18x1.5	ISO 8434-1-L	PLT4.2218.302	500	30	PLT4.2218.303	264	42
	85	71	12	15L	M22x1.5	ISO 8434-1-L	PLT4.2222.302	505	30	PLT4.2222.303	269	42
	85	71	12	18L	M26x1.5	ISO 8434-1-L	PLT4.2226.302	513	30	PLT4.2226.303	275	42
	87	73	14	22L	M30x2	ISO 8434-1-L	PLT4.2230.302	515	30	PLT4.2230.303	279	42
	85	71	12	10S	M18x1.5	ISO 8434-1-S	PLT4.2218.402	506	30	PLT4.2218.403	268	42
	85	71	12	12S	M20x1.5	ISO 8434-1-S	PLT4.2220.402	509	30	PLT4.2220.403	271	42
	87	73	14	14S	M22x1.5	ISO 8434-1-S	PLT4.2222.402	513	30	PLT4.2222.403	275	42
	87	73	14	16S	M24x1.5	ISO 8434-1-S	PLT4.2224.402	516	30	PLT4.2224.403	277	42
	89	75	16	20S	M30x2	ISO 8434-1-S	PLT4.2230.402	528	30	PLT4.2230.403	292	42

THREADS

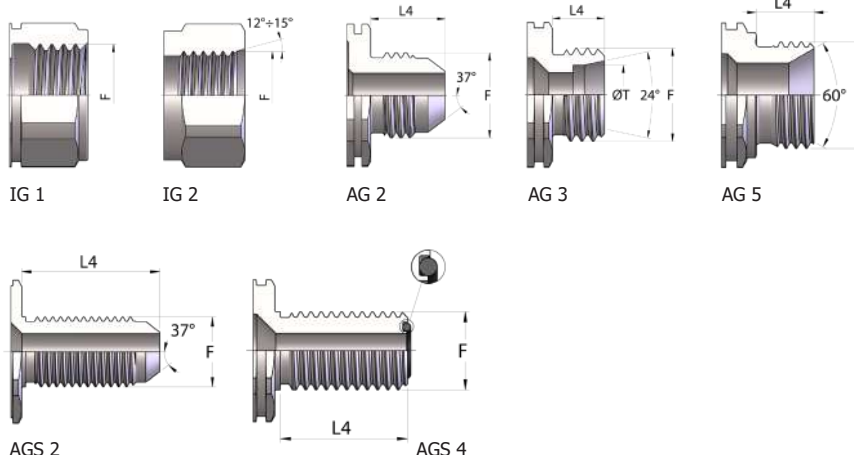



**PLT4 DN22 - BG 4A - ISO 16**

THREADS	L2	L3	L4	ØT	F	STANDARD	FEMMINA - FEMALE - MUFFE - FEMELLE			MASCIO - MALE - STECKER - MALE		
							COD. F	Weight (g)	Packaging (pcs.)	COD. M	Weight (g)	Packaging (pcs.)
<b>AGS 3</b>	99	85	26	12L	M18x1.5	ISO 8434-1-L	PLT4.2218.502	530	30	PLT4.2218.503	293	42
	100	86	27	15L	M22x1.5	ISO 8434-1-L	PLT4.2222.502	554	30	PLT4.2222.503	317	42
	100	86	27	18L	M26x1.5	ISO 8434-1-L	PLT4.2226.502	588	30	PLT4.2226.503	349	42
	107	93	34	22L	M30x2	ISO 8434-1-L	PLT4.2230.502	623	30	PLT4.2230.503	386	42
	100	86	27	10S	M18x1.5	ISO 8434-1-S	PLT4.2218.602	538	30	PLT4.2218.603	301	42
	100	86	27	12S	M20x1.5	ISO 8434-1-S	PLT4.2220.602	554	30	PLT4.2220.603	312	42
	102	88	29	14S	M22x1.5	ISO 8434-1-S	PLT4.2222.602	562	30	PLT4.2222.603	327	42
	102	88	29	16S	M24x1.5	ISO 8434-1-S	PLT4.2224.602	575	30	PLT4.2224.603	335	42
	107	93	34	20S	M30x2	ISO 8434-1-S	PLT4.2230.602	618	30	PLT4.2230.603	381	42

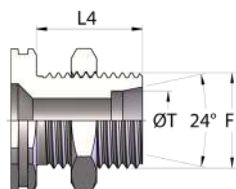
**THREADS**

AGS 3

PLT4 DN25 - BG 4 - ISO 19

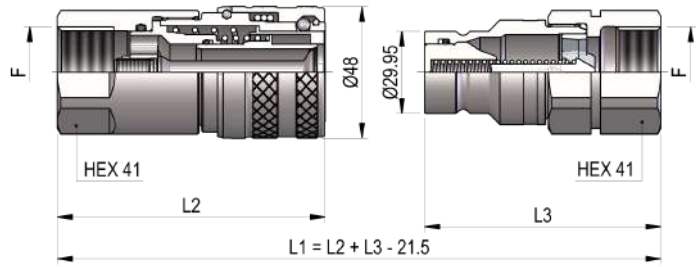

THREADS	L2	L3	L4	ØT	F	STANDARD	FEMMINA - FEMALE - MUFFE - FEMELLE			MASCHIO - MALE - STECKER - MALE		
							COD. F	Weight (g)	Packaging (pcs.)	COD. M	Weight (g)	Packaging (pcs.)
<b>IG 1</b>	94.5	86			BSP 3/4"	DIN 3852-2-X	PLT4.2519.112	808	23	PLT4.2519.113	478	30
	94.5	86			NPT 3/4"	ANSI B1.20.3	PLT4.2519.012	814	23	PLT4.2519.013	485	30
	94.5	86			RC 3/4"	EN 10226	PLT4.2519.042	816	23	PLT4.2519.043	485	30
	97.5	86			BSP 1"	DIN 3852-2-X	PLT4.2525.112	780	23	PLT4.2525.113	414	30
	97.5	86			NPT 1"	ANSI B1.20.3	PLT4.2525.012	786	23	PLT4.2525.013	427	30
	97.5	86			M30x1.5	ISO 6149-1	PLT4.2530.102	810	23	PLT4.2530.103	450	30
<b>IG 2</b>	95	86			1"1/16-12 UN 2B	SAE J 1926-1	PLT4.2527.032	817	23	PLT4.2527.033	471	30
	95	86			1"5/16-12 UN 2B	SAE J 1926-1	PLT4.2533.032	758	23	PLT4.2533.033	413	30
<b>AG 2</b>	99.1	90.1	23.1		1"5/16-12 UN 2A	SAE J 514	PLT4.2533.302	822	23	PLT4.2533.303	412	30
<b>AGS 2</b>	121.4	112.4	45.4		1"5/16-12 UN 2A	SAE J 514	PLT4.2533.502	881	23	PLT4.2533.503	510	30
<b>AG 5</b>	97	88	18		BSP 1"	DIN 3852-2-B	PLT4.2525.212	818	23	PLT4.2525.213	420	30
	95	84	17		BSP 1"	BS B5200	PLT4.2525.702	751	23	PLT4.2525.703	398	30
	95	86	16		BSP 3/4"	DIN 3852-2-A	PLT4.2519.712	797	23	PLT4.2519.713	396	30
	97	88	18		BSP 1"	DIN 3852-2-A	PLT4.2525.712	775	23	PLT4.2525.713	422	30
<b>AG 3</b>	97	79	12	18L	M26x1.5	ISO 8434-1-L	PLT4.2526.302	773	23	PLT4.2526.303	373	30
	99	81	14	22L	M30x2	ISO 8434-1-L	PLT4.2530.302	777	23	PLT4.2530.303	378	30
	99	81	14	28L	M36x2	ISO 8434-1-L	PLT4.2536.302	776	23	PLT4.2536.303	383	30
	101	83	16	20S	M30x2	ISO 8434-1-S	PLT4.2530.402	790	23	PLT4.2530.403	389	30
	103	85	18	25S	M36x2	ISO 8434-1-S	PLT4.2536.402	807	23	PLT4.2536.403	412	30
<b>AGS 3</b>	119	101	34	18L	M26x1.5	ISO 8434-1-L	PLT4.2526.502	864	23	PLT4.2526.503	461	30
	119	101	34	22L	M30x2	ISO 8434-1-L	PLT4.2530.502	882	23	PLT4.2530.503	486	30
	119	101	34	28L	M36x2	ISO 8434-1-L	PLT4.2536.502	910	23	PLT4.2536.503	524	30
	121	103	36	20S	M30x2	ISO 8434-1-S	PLT4.2530.602	902	23	PLT4.2530.603	503	30
	123	105	38	25S	M36x2	ISO 8434-1-S	PLT4.2536.602	960	23	PLT4.2536.603	565	30

THREADS

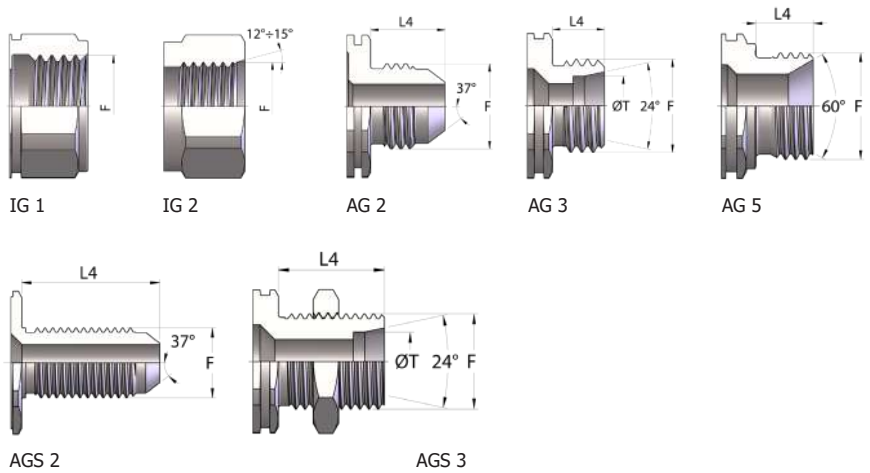

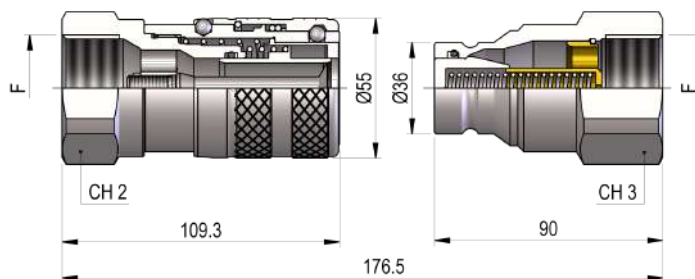
**PLT4 DN30 - BG 5 - ISO 25**

THREADS	CH2	CH3	F	STANDARD	FEMMINA - FEMALE - MUFFE - FEMELLE			MASCIO - MALE - STECKER - MALE		
					COD. F	Weight (g)	Packaging (pcs.)	COD. M	Weight (g)	Packaging (pcs.)
<b>IG 1</b>	50	50	BSP 1"	DIN 3852-2-X	PLT4.3025.112	1236	7	PLT4.3025.113	726	20
	50	50	NPT 1"	ANSI B1.20.3	PLT4.3025.012	1260	7	PLT4.3025.013	733	20
	55	55	BSP 1"¼	DIN 3852-2-X	PLT4.3031.112	1238	7	PLT4.3031.113	769	20
	55	55	NPT 1"¼	ANSI B1.20.3	PLT4.3031.012	1253	7	PLT4.3031.013	781	20
<b>IG 2</b>	50	50	1"5/16-12 UN 2B	SAE J 1926-1	PLT4.3033.032	1235	7	PLT4.3033.033	715	20
	55	55	1"5/8-12 UN 2B	SAE J 1926-1	PLT4.3041.032	1241	7	PLT4.3041.033	768	20

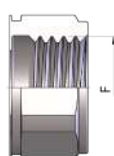
**THREADS**

IG 1

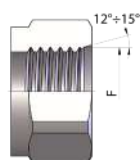

IG 2

**PLASTIC CAPS**

NOMINAL SIZE				FEMALE DUST PLUG				MALE DUST CAP				COLOR	MATERIAL	
DNP	BG	ISO	COD. F	Dimensions			Weight (g)	COD. M	Dimensions			Weight (g)		
				D	L	D1			D	L	D1			
06	1	6.3	SPLT.06002	32.5	200	20	16	SPLT.06003	26	200	20	13	●	PVC
13	2	10	SPLT.13002	37	200	26	21	SPLT.13003	27.5	200	26	15	●	PVC
20	3	12.5	SPLT.20002	43	200	31.5	29	SPLT.20003	35	200	31.5	26	●	PVC
25	4	19	SPLT.25002	53.5	265	35	51	SPLT.25003	43	265	35	41	●	PVC

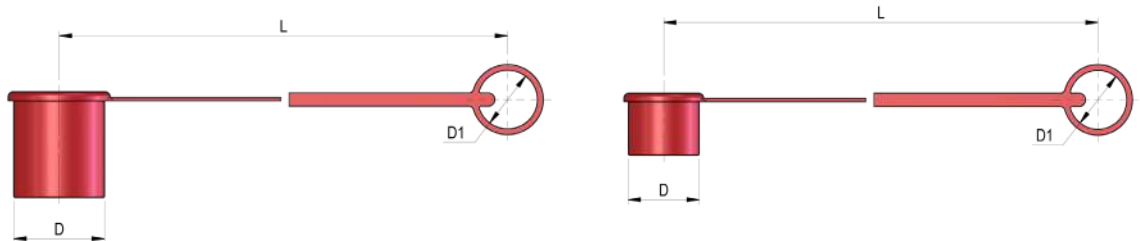

NOMINAL SIZE				FEMALE DUST PLUG				MALE DUST CAP				COLOR	MATERIAL	
DNP	BG	ISO	COD. F	Dimensions			Weight (g)	COD. M	Dimensions			Weight (g)		
				D	L	D1			D	L	D1			
22	4A	16	SPLT.22002	47	200	32.5	34	SPLT.22003	38	200	32.5	30	●	PVC
30	5	25	SPLT.30002	62	280	48	75	SPLT.30003	51	270	48	60	●	PVC



**METAL CAPS**

NOMINAL SIZE				FEMALE DUST PLUG				MALE DUST CAP				MATERIAL	
DNP	BG	ISO	COD. F	Dimensions			Weight (g)	COD. M	Dimensions			Weight (g)	
				D	L	D1			D	L	D1		
06	1	6.3	SPLT.06202	35	200	32	41	SPLT.06203	25	200	32	28	Aluminum
13	2	10	SPLT.13202	40	200	32	48	SPLT.13203	30	200	32	39	Aluminum
20	3	12.5	SPLT.20202	45	200	32	53	SPLT.20203	32	200	32	40	Aluminum
22	4A	16	SPLT.22202	50	200	32	63	SPLT.22203	35	200	32	43	Aluminum
25	4	19	SPLT.25202	55	275	47.5	74	SPLT.25203	40	275	47.5	66	Aluminum
30	5	25	SPLT.30202	65	275	47.5	126	SPLT.30203	45	275	47.5	71	Aluminum

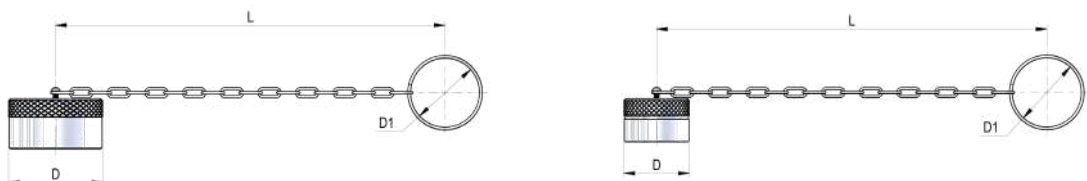

\*REALIZZATI SU RICHIESTA DEL CLIENTE  
 \*AVAILABLE ON REQUEST  
 \*AUF ANFRAGE LIEFERBAR  
 \*DISPONIBLES SUR DEMANDE

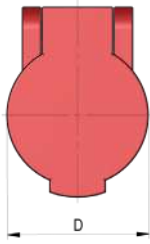
**AUTOMATIC CAPS**

NOMINAL SIZE			AUTOMATIC FEMALE CAP			COLOR	MATERIAL	
DNP	BG	ISO	COD. F	Dimensions				Weight (g)
				D	S			
13	2	10	SPLT.13302	38	16.8	17		Nylon
13	2	10	SPLT.13342	38	16.8	17		Nylon
20	3	12.5	SPPV.13302	46	18.4	24		Nylon
20	3	12.5	SPPV.13312	46	18.4	24		Nylon
20	3	12.5	SPPV.13322	46	18.4	24		Nylon
20	3	12.5	SPPV.13332	46	18.4	24		Nylon
20	3	12.5	SPPV.13342	46	18.4	24		Nylon

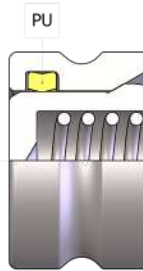
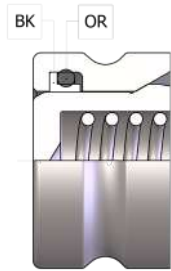
**SPARE PARTS**

NOMINAL SIZE			MALE GASKET		MALE GASKET
DNP	BG	ISO	OR (NBR*)	BK (PTFE)	PU (POLYURETHANE)
04	0	5	PLT.004.120	PLT.004.130	-
06	1	6.3	PLT.006.120	PLT.006.130	-
13	2	10	PLT.013.120	PLT.013.130	PLK.013.210
20	3	12.5	PLT.019.120	PLT.019.130	PVT.019.210
22	4A	16	PLT.022.120	PLT.022.130	PVT.022.210
25	4	19	PLT.025.120	PLT.025.130	PVT.025.210
30	5	25	PLT.031.120	PLT.031.130	PVT.030.210

\*AL CODICE DELLA GUARNIZIONE IN NBR AGGIUNGERE 'E' PER EPDM O 'V' PER VITON

\*TO THE NBR GASKET CODE ADD 'E' FOR EPDM OR 'V' FOR VITON

\*ZU DER ARTIKELNR. DER NBR DICHTUNG GEBEN SIE 'E' FUER EPDM ODER 'V' FUER VITON AN

\*AU CODE DU JOINT EN NBR JOINDRE 'E' POUR EPDM OU 'V' POUR VITON